

43-ESH ECONOMY TURBOSTAR EDV-NR.SA311 - GEHAEUSE, MOTOR, MESSERBALKEN

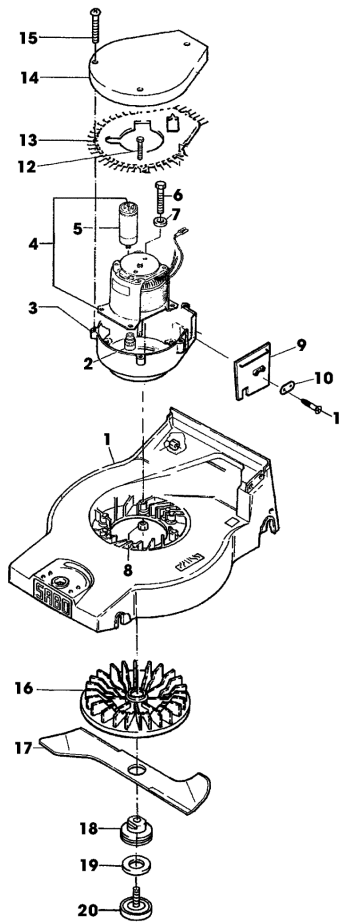

SA000615

43-ESH ECONOMY TURBOSTAR EDV-NR.SA311 - GEHAEUSE, MOTOR, MESSERBALKEN



TEIL	STCK.NR	BEZEICHNUNG	STCK.	SER-NR.-	-SER-NR.	BEMERKUNG
1	SAA33428	MAEHGEHAEUSE	1			
2	SA11239	DISTANZSTUECK	4			
3	SA16500	HALTER	1			
4	SA36642	ELEKTROMOTOR	1			1300W
5	SA30966	KONDENSATOR	1			20 MY/F
6	SA11188	SECHSKANTSCHRAUBE	4			M6X50
7	SA16504	SCHEIBE	4			
8	SA11244	SICHERUNGSMUTTER	4			M6
9	SA34517	FUEHRUNG	1			
10	SA34518	ANSCHLAG	1			
11	SA16267	SCHRAUBE	2			4,2X13
12	SA16267	SCHRAUBE	3			4,2X13
13	SA34275	LUFTFUEHRUNG	1			
14	SA16507	HAUBE	1			
15	SA16268	SCHRAUBE	3			4,2X32
16	SA35232	LUEFTER	1			(A) NSEP (ORD SAA10123)
17	SAA15166	MESSER	1			
18	SA34097	FLANSCH	1			(FOR SA35232)
19	SA34273	SCHEIBE	1			
20	SA37472	SCHRAUBE	1			(SUB FOR SA16549)
		(A) TEILESATZ SAA10123 BEINHALTET AUCH FLANSCH SA37318 UND SCHRAUBE SA37472				

43-ESH ECONOMY TURBOSTAR EDV-NR.SA311 - VORDER- UND HINTERACHSE

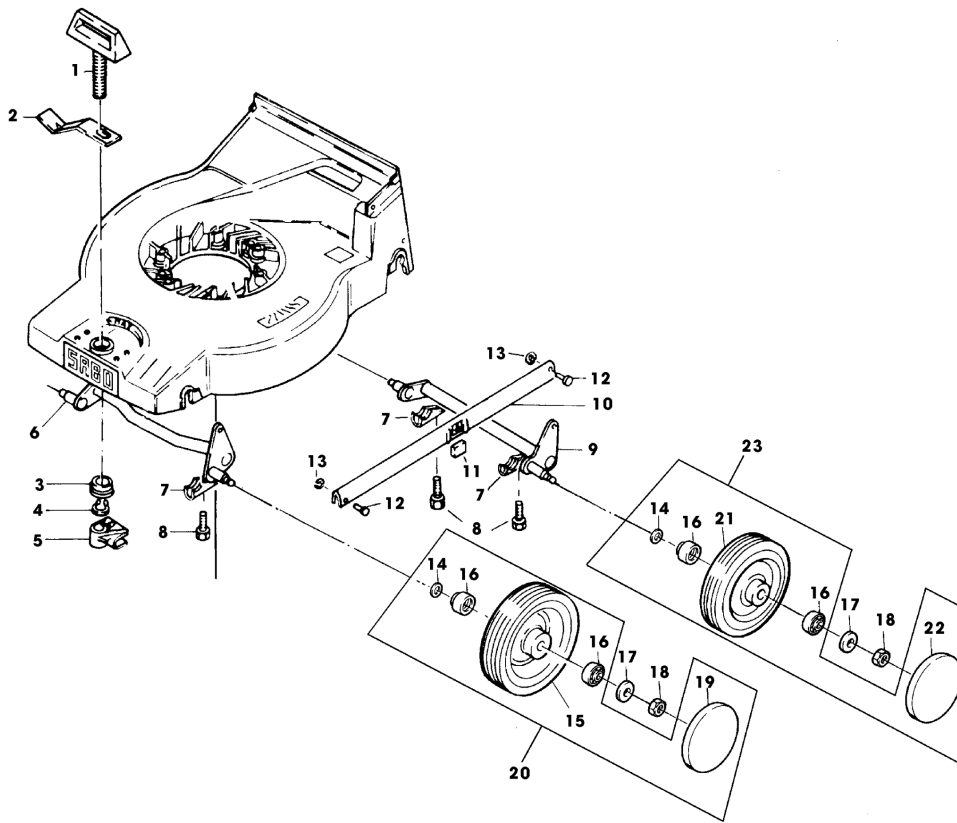

SA000525

43-ESH ECONOMY TURBOSTAR EDV-NR.SA311 - VORDER- UND HINTERACHSE



TEIL	STCK.NR	BEZEICHNUNG	STCK.	SER-NR.-	-SER-NR.	BEMERKUNG
1	SA15168	GRIFF	1			
2	SA15169	FEDER	1			
3	SAA11251	KUGELLAGER	1			
4	SA15691	SPRENGRING	1			9
5	SA15170	SCHALTKONSOLE	1			
6	SA15171	ACHSE	1			FRONT
7	SA36388	KLEMME	4			(SUB FOR SA15174)
8	SA29854	SCHRAUBE	4			M5X12
9	SA15172	ACHSE	1			REAR
10	SA15173	VERBINDUNGSSTANGE	1			
11	SA15191	ANSCHLAG	1			
12	SA17006	BOLZEN	2			6 H11X 13,5
13	H120499	FEDERMUTTER	2			(A) (SUB FOR SA31710)
14	SA35229	SCHEIBE	4			
15	SA34075	RAD KPL. MIT BEREIFUNG	2			(B) FRONT, 150 MM
16	SA33229	KUGELLAGER	8			
17	SA15213	UNTERLEGSCHIEBE	4			(A) A8,4
18	14M7327	SICHERUNGSMUTTER	4			(A) M8 (SUB FOR SA11998)
19	SA36551	DECKEL	2			FRONT
20	SA35401	RAD	2			ASSY FRONT, 150 MM
21	SA34392	RAD KPL. MIT BEREIFUNG	2			(C) REAR, 180 MM
22	SA36555	DECKEL	2			REAR
23	SAA35403	RAD	2			ASSY REAR, 180 MM
		(A) WERDEN NUR NOCH IN PACKMENGEN GELIEFERT				
		(B) WENN BESTAND AUFGEBRAUCHT BESTELLE BAUGRUPPE SA35401				
		(C) WENN BESTAND AUFGEBRAUCHT BESTELLE BAUGRUPPE SAA35403				

43-ESH ECONOMY TURBOSTAR EDV-NR.SA311 - FUEHRUNGSHOLM, STARTER

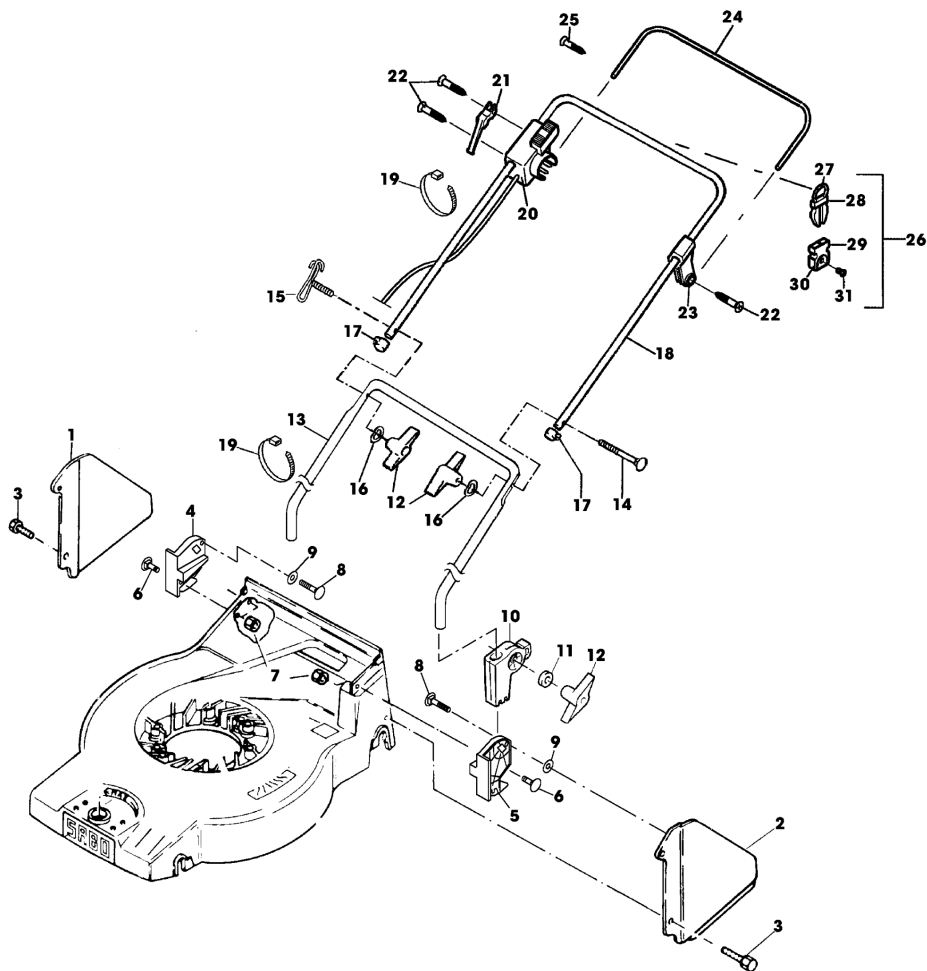

SA002631

43-ESH ECONOMY TURBOSTAR EDV-NR.SA311 - FUEHRUNGSHOLM, STARTER



TEIL	STCK.NR	BEZEICHNUNG	STCK.	SER-NR.-	-SER-NR.	BEMERKUNG
1	SA35312	ABSTUETZUNG	1			RH
2	SA35313	ABSTUETZUNG	1			LH
3	SA17604	SCHRAUBE	2			(A) M5X10
4	SA36310	HALTER	1			RH
5	SA36311	HALTER	1			LH
6	SA36312	SCHRAUBE	4			M6X25 (ORD SA15324, SA15212, SA37416)
7	SA15412	MUTTER	4			M6
8	SA18797	SCHRAUBE	2			M6X65
9	SA34429	FEDERSCHEIBE	2			
10	SA33256	HALTER	2			
11	SA15212	UNTERLEGSCHIEBE	2			(A) A6,4
12	SA31121	FLUEGELMUTTER	4			
13	SAA36309	FUEHRUNG	1			LOW
14	SA15632	SCHRAUBE	1			M6X45
15	SA35190	FUEHRUNG	1			
16	SA11243	UNTERLEGSCHIEBE	2			
17	SA15893	KAPPE	2			(A)
18	SA35311	LENKSTANGE	1			UP
19	RA1000652	KABELBINDER	2			(SUB FOR SA12505)
20	SA35345	KABELBAUM, ELEKTROMOTOR-	1			(B)
21	SA35202	HALTER	1			
22	SA16267	SCHRAUBE	4			(A) 4,2X13
23	SA34522	LAGER	1			
24	SAA35310	BUEGEL	1			
25	SA17249	SCHRAUBE	1			B 4,8X13
26	SA31745	KABELHALTER	1			ASSY
27		RING	1			NSEP (ORD SA31745)
28		VERRIEGELUNG	1			NSEP (ORD SA31745)
29		KABELHALTER	1			NSEP (ORD SA31745)
30		DECKEL	1			NSEP (ORD SA31745)
31		SCHRAUBE	1			NSEP (ORD SA31745) KBL 50X14

(A) WERDEN NUR
NOCH IN
PACKMENGEN
GELIEFERT

(B) AUSFUEHRUNG
SCHWEIZ

43-ESH ECONOMY TURBOSTAR EDV-NR.SA311 - FANGTUCH

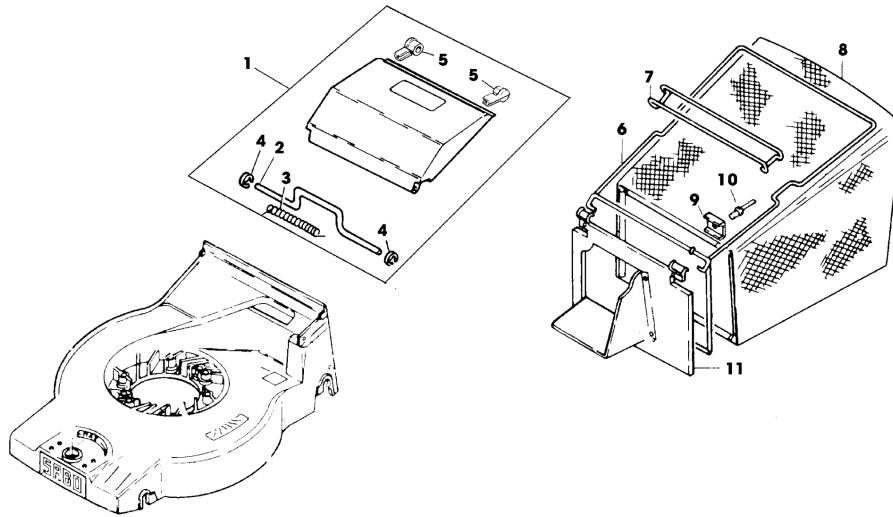

SA000524

43-ESH ECONOMY TURBOSTAR EDV-NR.SA311 - FANGTUCH

TEIL	STCK.NR	BEZEICHNUNG	STCK.	SER-NR.-	-SER-NR.	BEMERKUNG
1	SAA34593	KLAPPE	1			ASSY
2		BUEGEL	1			NSEP (ORD SAA34593)
3		FEDER	1			NSEP (ORD SAA34593)
4		RING	2			NSEP (ORD SAA34593)
5		DAEMPFER	2			NSEP (ORD SAA34593)
6	SAA16556	HALTER	1			
7	SAA16557	GRIFF	1			
8	SA16558	GRASFANGBEHAELTER	1			
9	SA17715	FEDERKLEMME	2			
10		NIET	2			3,9X5,7 (ORD SA15541, SA15200, SA15410)
11	SA16559	KLAPPE	1			
	SA560	GRASFANGBEHAELTER	1			ASSY

43-ESH ECONOMY TURBOSTAR EDV-NR.SA311 - AUFKLEBER

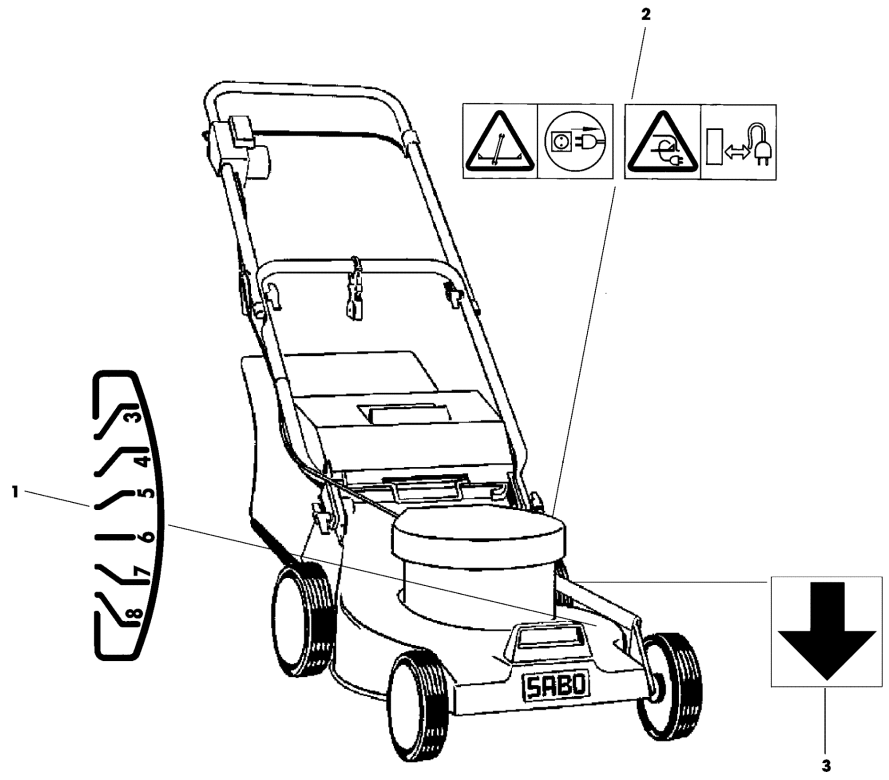

SA001160

43-ESH ECONOMY TURBOSTAR EDV-NR.SA311 - AUFKLEBER

TEIL	STCK.NR	BEZEICHNUNG	STCK.	SER-NR.-	-SER-NR.	BEMERKUNG
1	SA16352	AUFKLEBER	1			
2	SA35219	AUFKLEBER	1			
3	SA13820	AUFKLEBER	1			